

Creative Simplicity

Joiners & Accessories



AYRES
Lightweight Panel Systems

Joiners & Assembly Accessories Applications

The AYRES Joiners & Assembly Accessories are an integral component of the AYRES Lightweight Panel Systems. It provides a labour efficient and aesthetically enhancing assembly method and completes the AYRES Lightweight Panel Systems approach.

Features

- > Aluminium alloy 6000 series
- > Suits panels with thickness of 6mm, 10mm, 20mm, 30mm and 40mm or 0.236inch, 0.394inch, 0.787inch, 1.181inch and 1.575inch
- > Standard profile length is 4,900mm/16ft
- > Clear anodized finish, 10µm thickness

Fabrication

- > AYRES honeycomb panels are assembled with joiners using polyurethane adhesive e.g. Sikaflex 291. Ask our experienced AYRES team for any advice necessary.
- > An AYRES Assembly & Fabrication Techniques Videos are available on request

Safety

As with cutting operations on most materials, avoid inhalation and eye contact with machining dust. Wear protective equipment such as hearing protection and safety glasses during any cutting operations. Use machine guards. Wear gloves to avoid cuts. Wash hands before eating, drinking or smoking and after finishing work.

Door System



Access Panel



Furniture



6mm / 0.236inch Joiners

ACP094
Joiner



ACP115
Internal Corner



ACP82688
End Cap



10mm / 0.394inch Joiners

ACP131
End Cap



ACP83110
Channel



ACP83217
Corner Post



ACP81679
Corner Post Shallow Fit

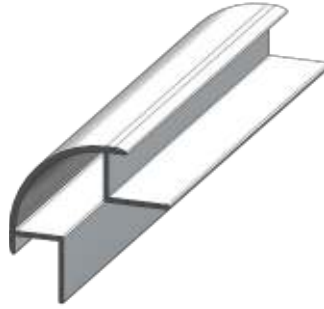

ACP83125
Corner Post Narrow



ACP8587

Cabinet Door Jamb



ACP81567

Cabinet Door Jamb with Retainer



ACP130

Joiner



ACP815602 Part Joiner Female
(working together with ACP81631 Bead Strip)

ACP80991

End Stop Short Leg

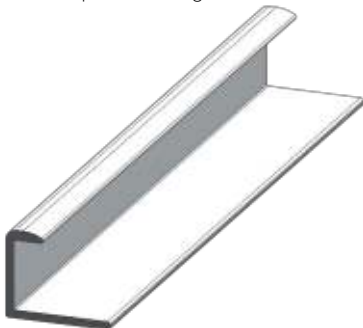

ACP81665

L Section



20mm / 0.787inch Joiners

ACP80360
End Cap



ACP83114
Channel Shallow



ACP81248
Channel Deep



ACP81247
T Section



ACP81520
H Joiner Deep

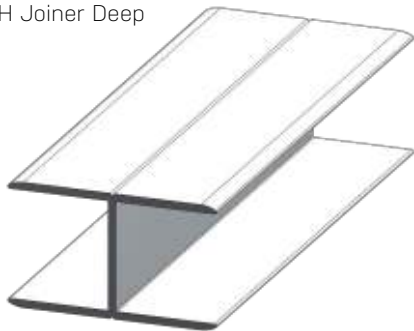

ACP82896
H Joiner Shallow

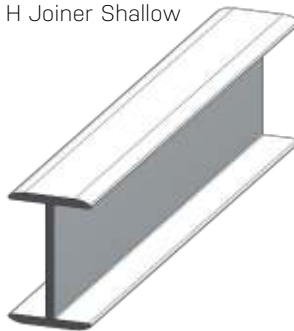

ACP81570
2 Part Joiner Female
(working together with
ACP81631 Bead Strip)

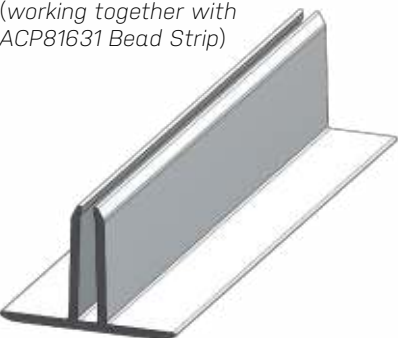

ACP81636
Corner Joiner



ACP83108
Corner Post

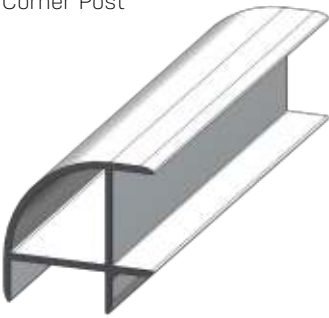

ACP2854
Cabinet Door Jamb



ACP81566
Cabinet Door Jamb with Retainer



ACP83791
Cabinet Door Keeper



ACP81587
L Section

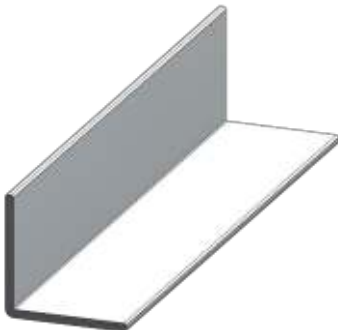

ACP8667
Shelf Edge



30mm / 1.181inch Joiners

ACP83107
Table Edge



40mm / 1.575inch Joiners

ACP83111
End Cap

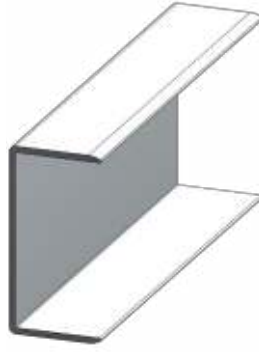

ACP83112
H Joiner



ACP83345
Corner Post

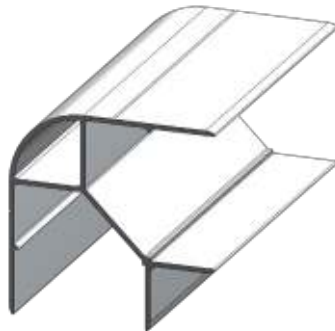

Universal Joiners

ACP80356

Internal Joiner (Suitable for Panels 10mm and over)



ACP81665

L Section (10mm)

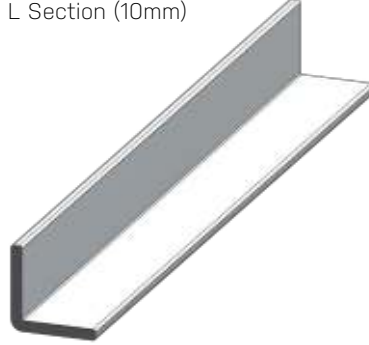

ACP80361

Corner Trim



ACP81588

135° Angle

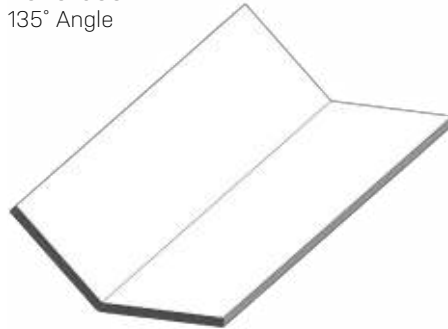

ACP81587

L Section (20mm)

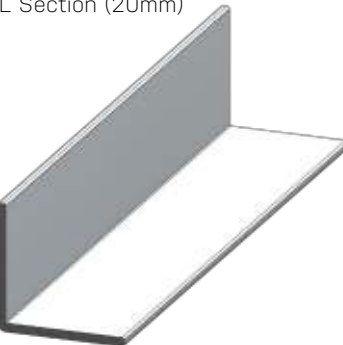

ACP81662

Sealing Strip Retainer



ACP81631

Bead Strip Serrated Tongue



20mm / 0.787inch DIY Door System

ACP80197
Door Stile



ACP81664
Threshold



ACP83220
Door Jamb



ACP1598
Door Jamb Joiner (ABS)

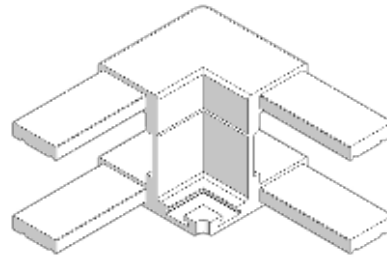

ACP2509
Felt Brush Pile



ACP2510
Countersunk Posi Drive S/S Screws



Skirting System

ACP83072

Skirting (60mmx6.7)



ACP83071

Skirting Fixing Cap



ACP3073

Skirting Cap LH

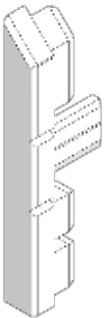

ACP3074

Skirting Cap RH

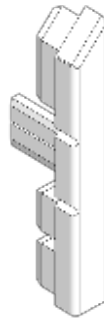

ACP1705

Corner Piece

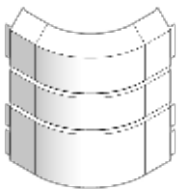

10mm / 0.394inch Assembly Accessories

ACP1432
External Corner

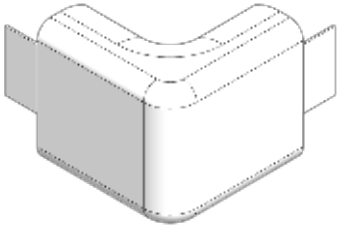

ACP1434
Internal Corner with Jamb

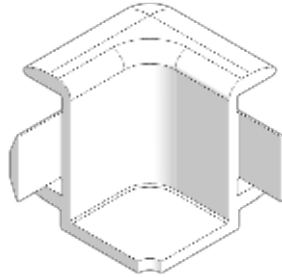

ACP1435
Corner Cap

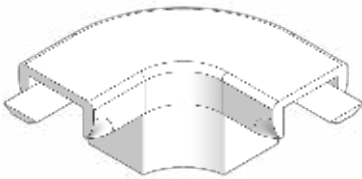

ACP1603
3 Way Joiner

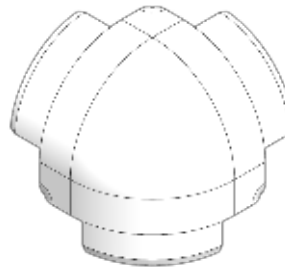

ACP1604
Internal Joiner

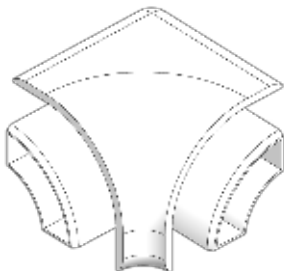

20mm / 0.787inch Assembly Accessories

ACP1532A

External Corner

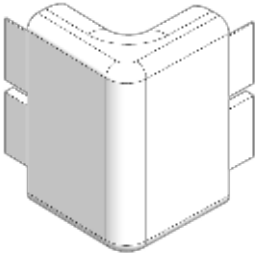

ACP1534

Internal Corner with Jamb

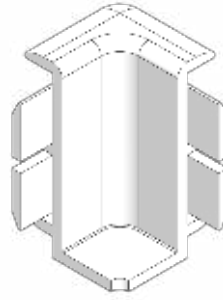

ACP1602

Corner Cap

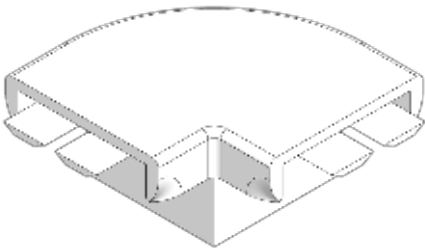

ACP1603

3 Way Joiner

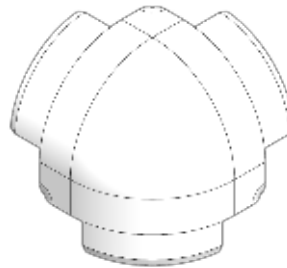

ACP1604

Internal Joiner

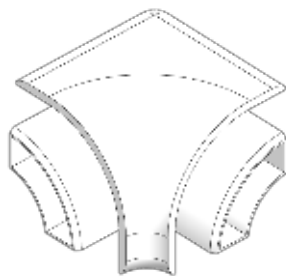

ACP1605

Shelf Edge Corner



20mm / 0.787inch Assembly Accessories

ACP1606

Corner Cap (suitable for ACP81636)

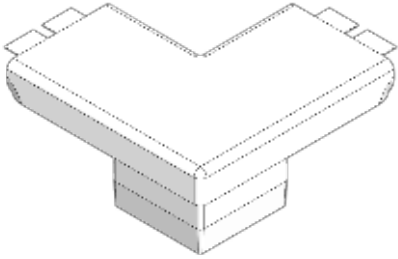

ACP1607

Corner Cap (Mitre Cut)

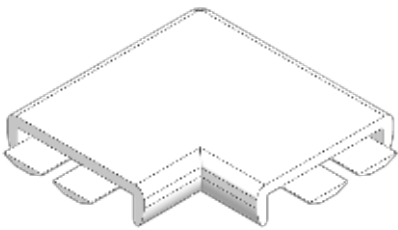

30mm / 1.181inch Assembly Accessories

ACP1701

Table Edge Corner



40mm / 1.575inch Assembly Accessories

ACP1832
External Corner

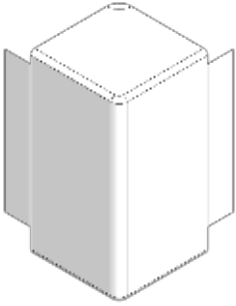

ACP1831
Corner Cap

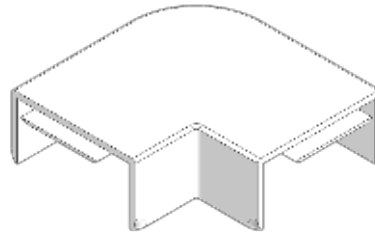

ACP1603
3 Way Joiner

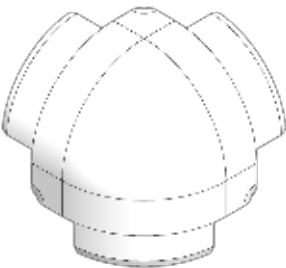

ACP1604
Internal Joiner

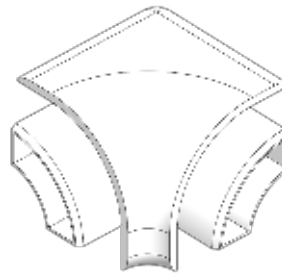

Description	Weight			
	Metric		Imperial	
6mm / 0.236inch Joiners				
ACP094 Joiner	0.13	kg/m	0.09	lb/ft
ACP115 Internal Corner	0.19	kg/m	0.13	lb/ft
ACP82688 End Cap	0.06	kg/m	0.04	lb/ft
10mm / 0.394inch Joiners				
ACP130 Joiner	0.17	kg/m	0.11	lb/ft
ACP131 End Cap	0.07	kg/m	0.05	lb/ft
ACP80991 End Stop Short Leg	0.10	kg/m	0.07	lb/ft
ACP81560 2 Part Joiner Female	0.19	kg/m	0.13	lb/ft
ACP81567 Cabinet Door Jamb (with Retainer)	0.12	kg/m	0.08	lb/ft
ACP81665 L Section	0.09	kg/m	0.06	lb/ft
ACP81679 Corner Post Shallow Fit	0.34	kg/m	0.23	lb/ft
ACP83110 Channel	0.11	kg/m	0.07	lb/ft
ACP83125 Corner Post Narrow	0.31	kg/m	0.21	lb/ft
ACP83217 Corner Post	0.44	kg/m	0.29	lb/ft
ACP8587 Cabinet Door Jamb	0.11	kg/m	0.07	lb/ft
20mm / 0.787inch Joiners				
ACP2854 Cabinet Door Jamb	0.15	kg/m	0.10	lb/ft
ACP80360 End Cap	0.12	kg/m	0.08	lb/ft
ACP81247 T Section	0.12	kg/m	0.08	lb/ft
ACP81248 Channel Deep	0.24	kg/m	0.16	lb/ft
ACP81520 H Joiner Deep	0.40	kg/m	0.27	lb/ft
ACP81566 Cabinet Door Jamb (with Retainer)	0.17	kg/m	0.11	lb/ft
ACP81570 2 Part Joiner Female	0.27	kg/m	0.18	lb/ft
ACP81587 L Section	0.17	kg/m	0.11	lb/ft
ACP81636 Corner Joiner	0.67	kg/m	0.45	lb/ft
ACP82896 H Joiner Shallow	0.20	kg/m	0.13	lb/ft
ACP83108 Corner Post	0.46	kg/m	0.31	lb/ft
ACP83114 Channel Shallow	0.16	kg/m	0.11	lb/ft
ACP83791 Cabinet Door Keeper	0.20	kg/m	0.13	lb/ft
ACP8667 Shelf Edge	0.27	kg/m	0.18	lb/ft
30mm / 1.181inch Joiners				
ACP83107 Table Edge	0.24	kg/m	0.16	lb/ft
40mm / 1.575inch Joiners				
ACP83111 End Cap	0.33	kg/m	0.22	lb/ft
ACP83112 H Joiner	0.49	kg/m	0.33	lb/ft
ACP83345 Corner Post	0.93	kg/m	0.62	lb/ft
Universal Joiners				
ACP80356 Internal Joiner	0.12	kg/m	0.08	lb/ft
ACP80361 Corner Trim	0.18	kg/m	0.12	lb/ft

Description	Weight			
	Metric		Imperial	
Universal Joiners continued				
ACP81587 L Section (20mm)	0.17	kg/m	0.11	lb/ft
ACP81588 135° Angle	0.16	kg/m	0.11	lb/ft
ACP81631 Bead Strip Serrated Tongue	0.05	kg/m	0.03	lb/ft
ACP81662 Sealing Strip Retainer	0.05	kg/m	0.04	lb/ft
ACP81665 L Section (10mm)	0.09	kg/m	0.06	lb/ft
20mm / 0.787inch DIY Door System				
ACP1598 Door Jamb Joiner (ABS)	27.20	g/each	0.96	oz/each
ACP2509 Felt Brush Pile	4.70	g/m	0.16	oz/ft
ACP2510 Stainless Steel Screws	7.6	g/each	0.27	oz/each
ACP80197 Door Stile	1.16	kg/m	0.77	lb/ft
ACP81664 Threshold	0.75	kg/m	0.51	lb/ft
ACP83220 Door Jamb	0.64	kg/m	0.43	lb/ft
Skirting System				
ACP1705 Corner Piece	11.00	g/each	0.39	oz/each
ACP3073 Skirting Cap LH	3.00	g/each	0.11	oz/each
ACP3074 Skirting Cap RH	3.00	g/each	0.11	oz/each
ACP83071 Skirting Fixing Cap	0.07	kg/m	0.05	lb/ft
ACP83072 Skirting (60mm x 6.7mm)	0.33	kg/m	0.22	lb/ft
10mm / 0.394inch Assembly Accessories				
ACP1432 External Corner	1.00	g/each	0.04	oz/each
ACP1434 Internal Corner with Jamb	1.00	g/each	0.03	oz/each
ACP1435 Corner Cap	3.70	g/each	0.13	oz/each
ACP1603 3 Way Joiner	16.00	g/each	0.56	oz/each
ACP1604 Internal Joiner	10.40	g/each	0.37	oz/each
20mm / 0.787inch Assembly Accessories				
ACP1532A External Corner	1.70	g/each	0.06	oz/each
ACP1534 Internal Corner with Jamb	1.80	g/each	0.06	oz/each
ACP1602 Corner Cap	4.70	g/each	0.16	oz/each
ACP1603 3 Way Joiner	16.00	g/each	0.56	oz/each
ACP1604 Internal Joiner	10.40	g/each	0.37	oz/each
ACP1605 Shelf Edge Corner	9.20	g/each	0.32	oz/each
ACP1606 Corner Cap (suitable for ACP81636)	6.50	g/each	0.23	oz/each
ACP1607 Corner Cap (Mitre Cut)	3.00	g/each	0.11	oz/each
30mm / 1.181inch Assembly Accessories				
ACP1701 Table Edge Corner	13.40	g/each	0.47	oz/each
40mm / 1.575inch Assembly Accessories				
ACP1603 3 Way Joiner	16.00	g/each	0.56	oz/each
ACP1604 Internal Joiner	10.40	g/each	0.37	oz/each
ACP1831 Corner Cap	19.80	g/each	0.70	oz/each
ACP1832 External Corner	6.60	g/each	0.23	oz/each



AYRES
Lightweight Panel Systems

AYRES Composite Panels PTY LTD
21 – 23 Clune Street
Bayswater WA 6053
Australia

+61 8 9279 3246
enquiries@ayrescom.com

AYRES Composite Panels USA LLC
5460 Business Parkway
Theodore AL. 36582
USA

+1 251 653 0700
usa@ayrescom.com

Lighten Up!

®Registered Trade Mark of AYRES Composite Panels

IMPORTANT All information is given in good faith but without acceptance of liability. Ayres Composite Panels reserves the right to alter specification without prior notice. It remains the responsibility of the customer to ensure the suitability of any product for the purposes intended. All sales are made subject to Ayres Composite Panels standard terms and conditions of sale. Please direct all enquiries here.

v2207